

3-641435-4 ✓ ACTIVE

## MTA 156

TE Internal #: 3-641435-4

Rectangular Power Connectors, Connector Assembly, Plug, Wire-to-Wire, 4 Position, 3.96 mm [.156 in] Centerline, Wire & Cable, UL 94V-2, MTA 156

[View on TE.com >](#)



Connectors > Power Connectors > Rectangular Power > Rectangular Power Connectors

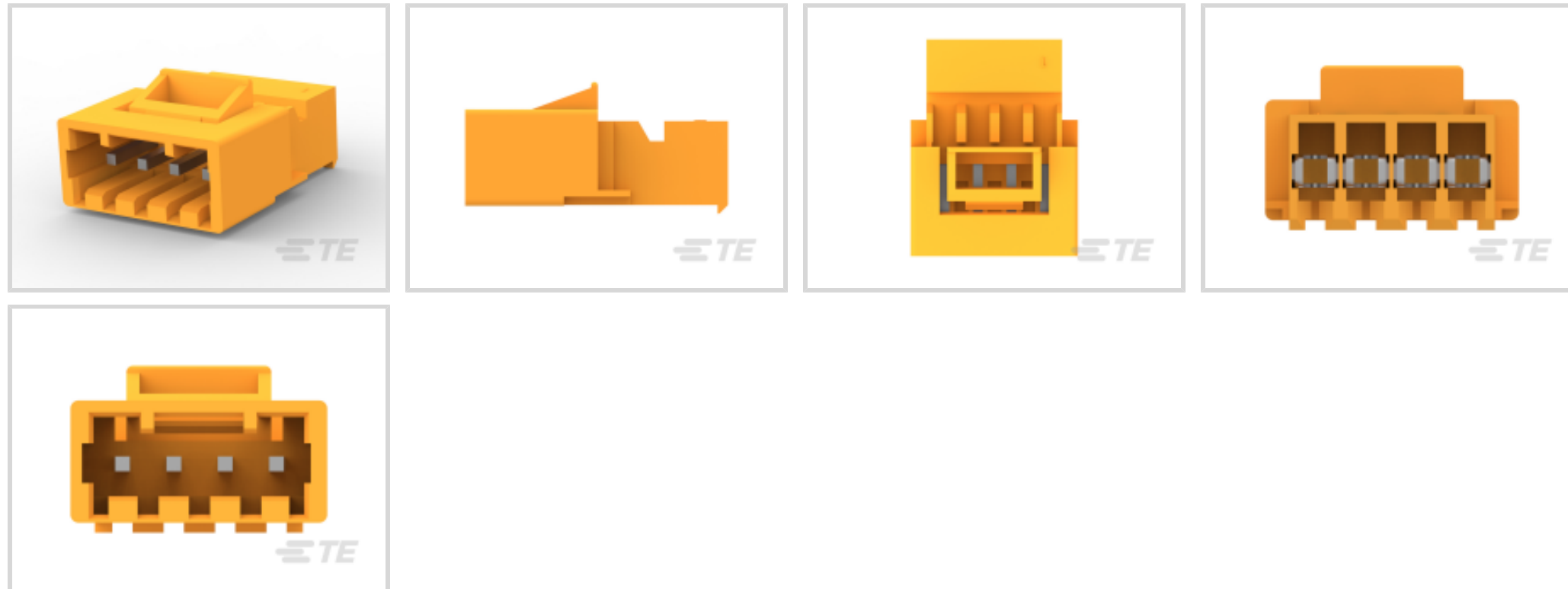

Rectangular Power Connector Type: **Connector Assembly**

Connector & Housing Type: **Plug**

Connector System: **Wire-to-Wire**

Number of Positions: **4**

Centerline (Pitch): **3.96 mm [.156 in]**

### Features

#### Product Type Features

Rectangular Power Connector Type	Connector Assembly
Connector & Housing Type	Plug
Connector System	Wire-to-Wire
Sealable	No
Connector & Contact Terminates To	Wire & Cable

#### Configuration Features

Number of Positions	4
Number of Power Positions	4
Number of Rows	1

#### Electrical Characteristics

Operating Voltage	600 VAC
-------------------	---------

#### Contact Features

Contact Layout	Inline
Contact Underplating Material	Nickel



Contact Base Material	Copper Alloy
Contact Current Rating (Max)	7 A
Contact Retention Within Housing	With
Contact Type	Pin
Wire Contact Termination Area Plating Material	Tin
Contact Mating Area Plating Material	Tin
Contact Mating Area Plating Material Thickness	2.03 $\mu\text{m}$ [80 $\mu\text{in}$ ]
Contact Mating Area Plating Material Finish	Matte
Underplate Material Thickness	50 $\mu\text{m}$ [1.27 $\mu\text{in}$ ]
Contact Termination Area Plating Thickness	2.03 $\mu\text{m}$ [80 $\mu\text{in}$ ]

### Termination Features

Termination Method to Wire & Cable	Insulation Displacement (IDC)
Wire/Cable Type	Discrete Wire
Wire Type	Stranded

### Mechanical Attachment

Strain Relief	With
Mating Alignment Type	Polarization
Mating Alignment	With
Contact Retention Type Within Housing	Locking Lance
PCB Mount Alignment	Without
Panel Mount Feature	Without
PCB Mount Retention	Without
Connector Mounting Type	Cable Mount (Free-Hanging)
Mating Retention	With
Mating Retention Type	Latch

### Housing Features

Wire & Cable IDC Installation Type	Closed End
Centerline (Pitch)	3.96 mm [.156 in]
Housing Color	Orange
Housing Material	Nylon
Cable Exit Angle	90°

### Dimensions

--	--



Wire Size	.8 – .9 mm <sup>2</sup>
Height	12.37 mm
Accepts Wire Insulation Diameter Range	2.41 mm [.095 in]
Length	19.81 mm

### Usage Conditions

Operating Temperature Range	-55 – 105 °C [-67 – 221 °F]
-----------------------------	-----------------------------

### Operation/Application

Circuit Application	Power
---------------------	-------

### Industry Standards

CSA Rating	Certified
UL Flammability Rating	UL 94V-2
Glow Wire Rating	Standard Part - Not Glow Wire
Agency/Standard Number	E28476
Agency/Standard	CSA, UL
UL Rating	Recognized
CSA File Number	LR7189

### Packaging Features

Packaging Method	Package
Packaging Quantity	1500

### Other

For Use With	MTA .156 Connector Assembly
--------------	-----------------------------

### Product Compliance

[For compliance documentation, visit the product page on TE.com>](#)

EU RoHS Directive 2011/65/EU	Compliant
EU ELV Directive 2000/53/EC	Compliant
China RoHS 2 Directive MIIT Order No 32, 2016	No Restricted Materials Above Threshold
EU REACH Regulation (EC) No. 1907/2006	Current ECHA Candidate List: JUNE 2022 (224) Candidate List Declared Against: JUNE 2022 (224) Does not contain REACH SVHC
Halogen Content	Low Halogen - Br, Cl, F, I < 900 ppm per homogenous material. Also BFR/CFR/PVC



Free

Solder Process Capability

Not applicable for solder process capability

Product Compliance Disclaimer

This information is provided based on reasonable inquiry of our suppliers and represents our current actual knowledge based on the information they provided. This information is subject to change. The part numbers that TE has identified as EU RoHS compliant have a maximum concentration of 0.1% by weight in homogenous materials for lead, hexavalent chromium, mercury, PBB, PBDE, DBP, BBP, DEHP, DIBP, and 0.01% for cadmium, or qualify for an exemption to these limits as defined in the Annexes of Directive 2011/65/EU (RoHS2). Finished electrical and electronic equipment products will be CE marked as required by Directive 2011/65/EU. Components may not be CE marked. Additionally, the part numbers that TE has identified as EU ELV compliant have a maximum concentration of 0.1% by weight in homogenous materials for lead, hexavalent chromium, and mercury, and 0.01% for cadmium, or qualify for an exemption to these limits as defined in the Annexes of Directive 2000/53/EC (ELV). Regarding the REACH Regulation, the information TE provides on SVHC in articles for this part number is based on the latest European Chemicals Agency (ECHA) 'Guidance on requirements for substances in articles' posted at this URL: <https://echa.europa.eu/guidance-documents/guidance-on-reach>

### Compatible Parts



TE Part # 58074-1  
MTA 50/100/156 MANUAL TOOL FRAME



TE Part # 3-640602-4  
04P MTA156 CONN ASSY 24AWG LF



TE Part # 643067-4  
04P MTA156 CMOLDED COVER



TE Part # 3-640429-4  
04P MTA156 CONN ASSY 24AWG WHT



TE Part # 3-640427-4  
04P MTA156 CONN ASSY 20AWG YEL



TE Part # 3-640600-4  
04P MTA156 CONN ASSY 20AWG LF



TE Part # 3-640428-4  
04P MTA156 CONN ASSY 22AWG RED



TE Part # 3-640426-4  
04P MTA156 CONN ASSY 18AWG ORA



TE Part # 640551-4  
04P MTA156 COVER



TE Part # 640643-4  
04P MTA156 COVER F/T



TE Part # 3-640599-4  
04P MTA156 CONN ASSY 18AWG ORA



TE Part # 3-640601-4  
04P MTA156 CONN ASSY 22AWG LF

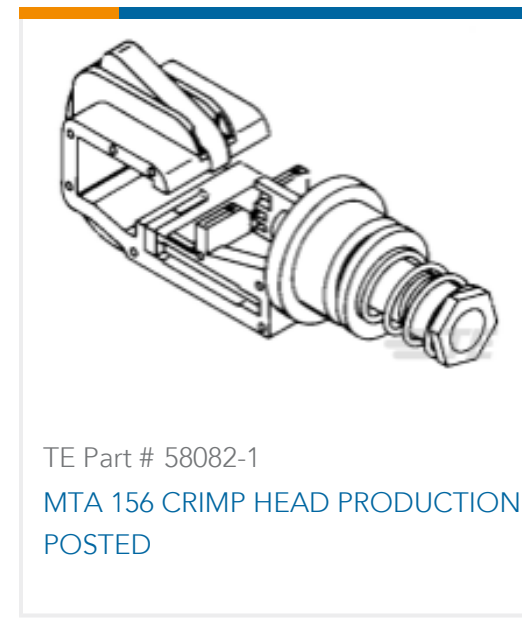

## Also in the Series | MTA 156

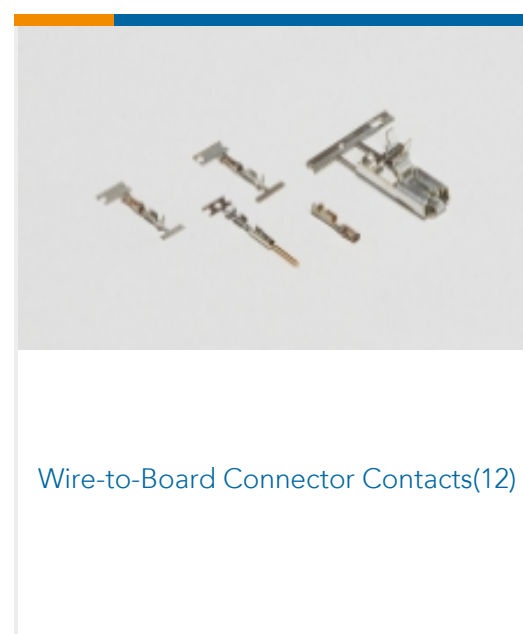
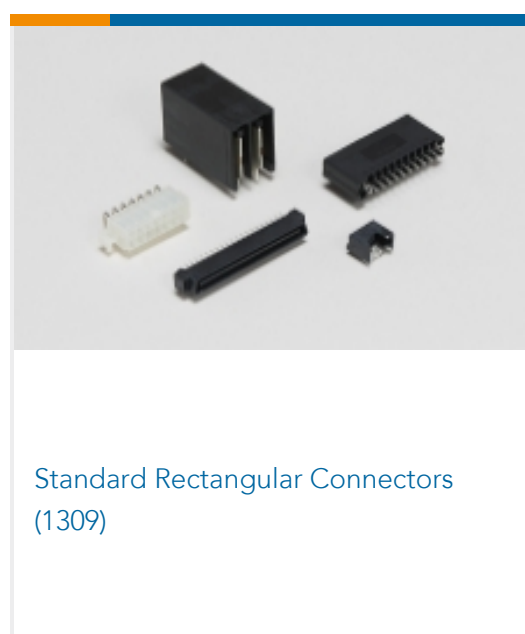
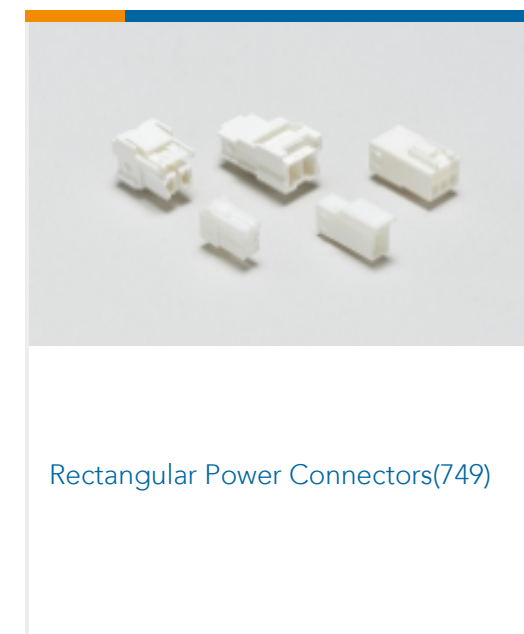
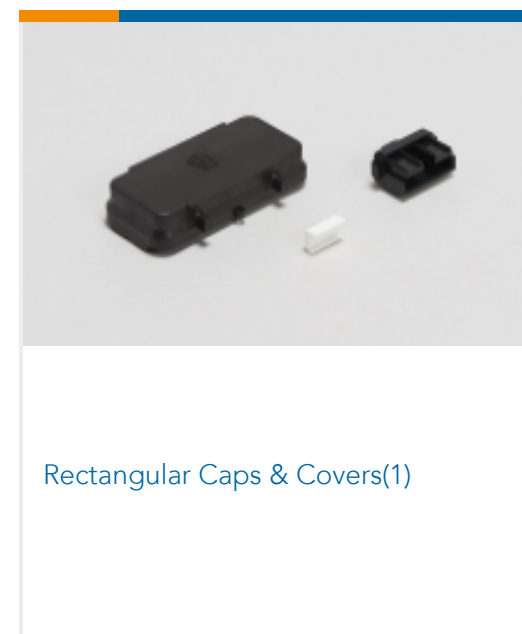
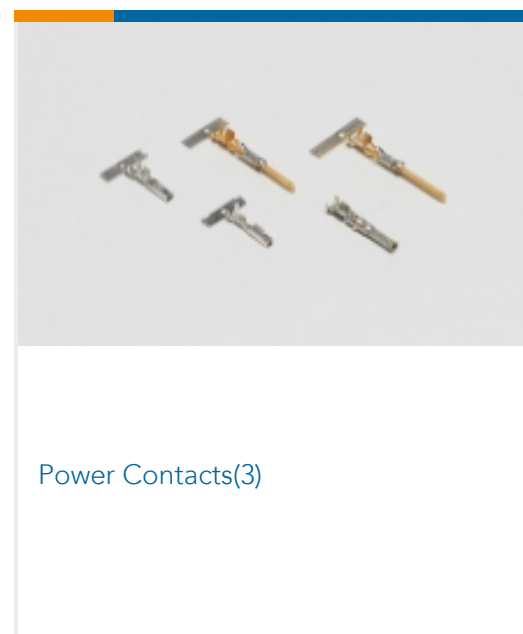
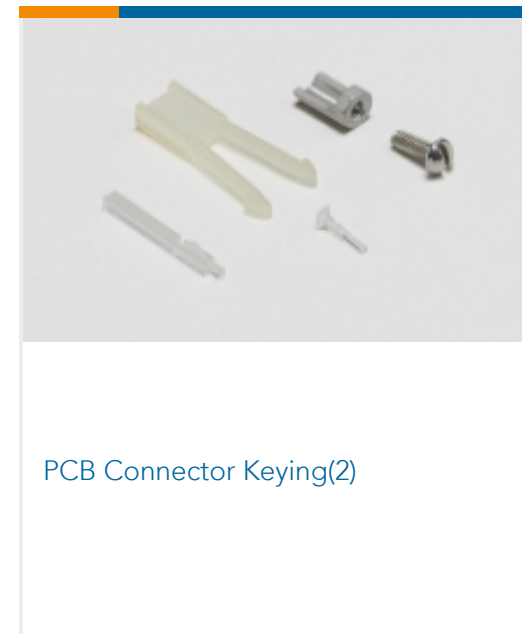
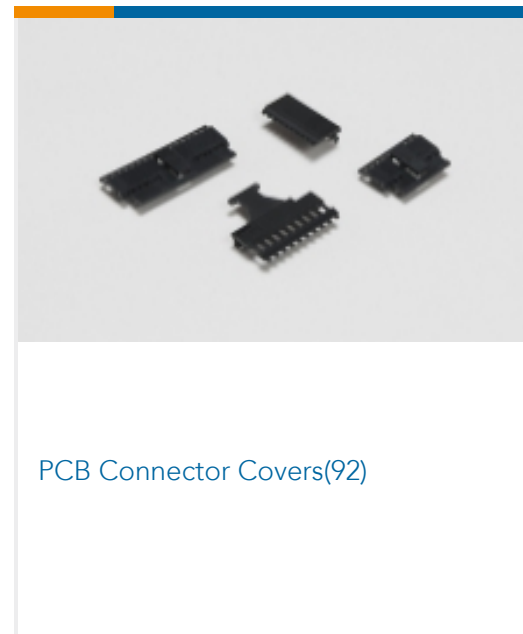
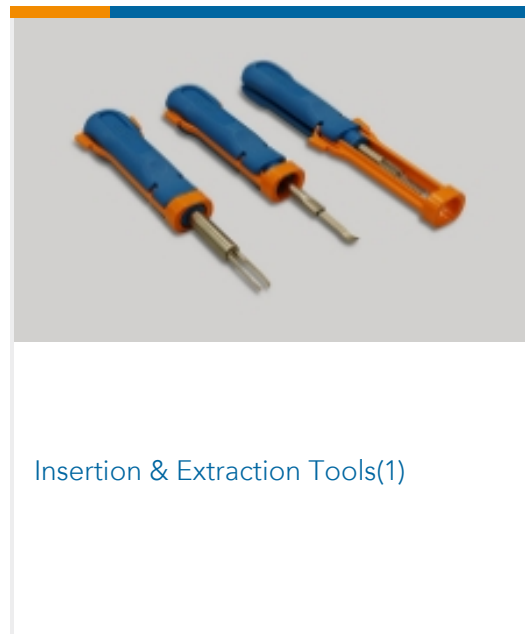

## Documents



**Product Drawings**

[04P MTA156 CONN ASSY ORNG](#)

English

---

**CAD Files**

[3D PDF](#)

3D

**Customer View Model**

[ENG\\_CVM\\_CVM\\_3-641435-4\\_K.2d\\_dxf.zip](#)

English

**Customer View Model**

[ENG\\_CVM\\_CVM\\_3-641435-4\\_K.3d\\_igs.zip](#)

English

**Customer View Model**

[ENG\\_CVM\\_CVM\\_3-641435-4\\_K.3d\\_stp.zip](#)

English

By downloading the CAD file I accept and agree to the [Terms and Conditions](#) of use.

---

**Datasheets & Catalog Pages**

[MTA, CST-100 II, SL-156 and AMP Economy Power \(EP\) Connectors](#)

English

---

**Product Specifications**

[Product Specification](#)

English

---

**Product Environmental Compliance**

[Product Compliance](#)

English

[Product Compliance](#)

English

---

**Agency Approvals**

[UL Report](#)

English